

## Package Contents

- 4K Ultra HD Bullet IP Camera
- Mounting Kit\*
- Ethernet Extension Cable with Pre-attached RJ45 Cable Gland\*

\* Per camera in multi-camera packs.

### ATTENTION:

It is recommended to connect the camera to the NVR or an external PoE switch. If using a DC power adapter (not included) with the camera, a REGULATED power supply is REQUIRED for use with this camera. Use of a non-regulated, non-conforming power supply can damage this product and voids the warranty.

## Camera Overview

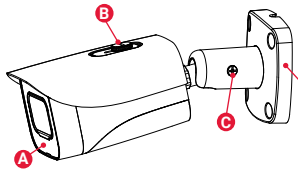

- A. Light Sensor and IR LEDs
- B. Sun Shield Screw
- C. Adjustment Screw
- D. Camera Base

## Dimensions

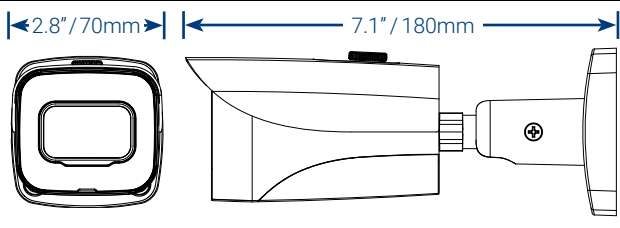

## Using the RJ45 Cable Gland (Optional)

The RJ45 cable gland covers the camera's Ethernet connector and the RJ45 plug to provide weather-resistance and protection from dust, dirt and other environmental contaminants.

The RJ45 cable gland is pre-attached to the included Ethernet extension cable.



### To use the RJ45 cable gland:

Twist the RJ45 cable gland barrel securely onto the camera Ethernet connector.

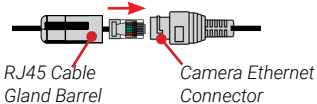

**NOTE:** The RJ45 cable gland is weather-resistant. Seal the cap with silicone and/or electrical tape for additional sealing if it will be exposed to precipitation regularly.

## Resources

### Need Help?

Visit us online for up-to-date software and complete instruction manuals

- 1 Visit [lorex.com](http://lorex.com)
- 2 Search for the model number of your product
- 3 Click on your product in the search results
- 4 Click on the **Downloads** tab



## Safety Precautions

- Use the camera only with compatible Lorex NVRs.
- Read this guide carefully and keep it for future reference.
- Follow all instructions for safe use of the product and handle with care.
- Use the camera within given temperature, humidity and voltage levels noted in the camera's specifications.
- Do not disassemble the camera.
- Do not point the camera directly towards the sun or a source of intense light.
- Use only a regulated power supply with the product (optional). Use of a non-regulated, non-conforming power supply can damage the product and void the warranty.
- Periodic cleaning may be required. Use a damp cloth only. Do not use harsh cleaners or aerosol cleaners.
- The supplied cable is rated for surface mounting only. Cables for in-wall and floor-to-floor installations are sold separately (CMR type). These and other cables are available at [lorex.com](http://lorex.com).

## Disclaimers

- For a full list of compatible recorders, visit [lorex.com/compatibility](http://lorex.com/compatibility).
- Not intended for submersion in water. Installation in a sheltered location recommended.
- This camera includes an Auto Mechanical IR Cut Filter. When the camera changes between Day/Night viewing modes, an audible clicking noise may be heard from the camera. This clicking is normal, and indicates that the camera filter is working.

# LOREX®

## 4K Ultra HD Bullet IP Camera

### Quick Start Guide English Version 1.0



## E841CA SERIES

[lorex.com](http://lorex.com)

Copyright © 2020 Lorex Corporation

As our products are subject to continuous improvement, Lorex reserves the right to modify product design, specifications and prices, without notice and without incurring any obligation. E&OE. All rights reserved.

E841CA\_QSG\_EN\_R1

## Installation Tips

- Point the camera where there is the least amount of obstructions (i.e., tree branches).
- Install the camera where vandals cannot easily reach.
- Secure cabling so that it is not exposed or easily cut.
- This camera is rated for outdoor use. Installation in a sheltered location is recommended.

## Installing the Camera

### ATTENTION:

Test your camera prior to selecting a permanent mounting location by temporarily connecting the camera and cable to your NVR.

### Before Installing the Camera

- Decide whether to run the cables through the wall / ceiling (drilling required) or along the wall / ceiling.
- If you run the cables along the wall / ceiling, you must run the cable through the **cable notch** on the base. This will keep the camera base flush to the surface when mounted.

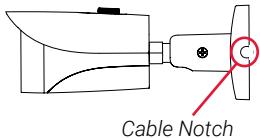

### To install your camera:

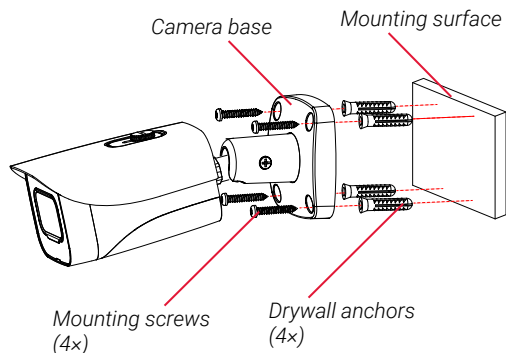

1. Use the included mounting template to mark holes for the screws. Drill holes for the mounting screws.

**NOTE:** Insert the included drywall anchors if you are installing the camera in drywall.

2. Connect cables as shown in the section "Connecting the Camera".
3. Feed the cable through the mounting surface or cable notch and mount the camera stand to the surface using the provided screws.
4. Use a Philips screwdriver (not included) to loosen the adjustment screw.

5. Adjust the camera position as needed.

6. Tighten the adjustment screw to secure the position.

7. Remove the vinyl film from the camera lens when your installation is complete.

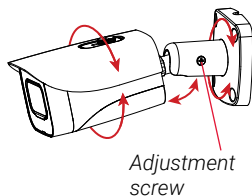

## Connecting the Camera

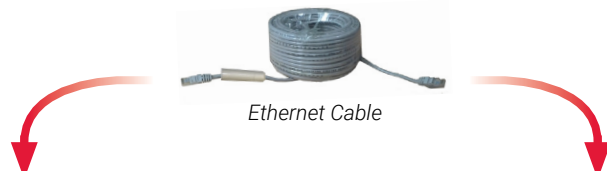

**Camera**

(Optional)  
12V DC Power

Connect the Ethernet cable to the camera.

**NOTE:** A 12V DC power adapter (model #: **ACCPWR12V1**, not included) is only required if connecting the camera's Ethernet cable to a router or switch that does not support PoE.

**NVR**

Connect the other end of the Ethernet cable to the NVR's PoE ports. The camera may take a minute to power up after being connected.

**OR**

Connect the other end of the Ethernet cable to a router or switch on your network. See your NVR manual for details on connecting the camera to your NVR using a switch or router.

## Setup Diagram

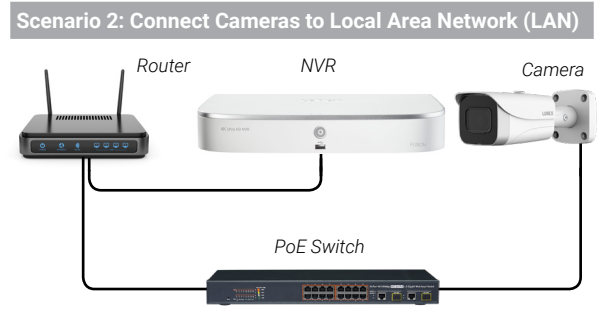
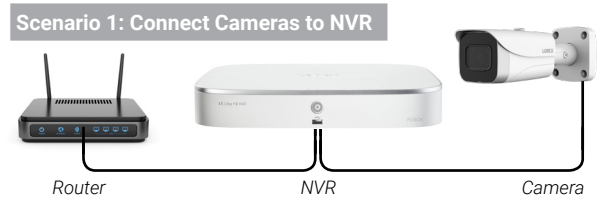

### ATTENTION:

- This camera is compatible only with select NVRs supporting 4K camera input. For a list of compatible recorders, visit [lorex.com/compatibility](http://lorex.com/compatibility).
- You must connect the camera to a supporting H.265 NVR to take advantage of H.265 compression. For instructions on enabling H.265 compression, visit [lorex.com](http://lorex.com) and search for "How do I enable H.265 compression?".

## Cable Extension Options

Extend the Ethernet cable run for your camera up to 300ft (91m). See table below. It is recommended to use UL CMR approved cables available at [lorex.com](http://lorex.com).

Cable Type	Max Cable Run Distance	Max # of Extensions
CAT5e (or higher) Ethernet cable	300ft (91m)	3

- You can use a RJ45 coupler or switch (not included) to connect male ends of Ethernet cable together.
- To extend the cable run beyond 300ft (91m), a switch will be required (sold separately).

## Troubleshooting

Problem	Solution
No picture / signal	<ul style="list-style-type: none"> <li>• Ensure the camera is connected to a compatible NVR supporting 4K camera input. For full camera compatibility, visit <a href="http://lorex.com/compatibility">lorex.com/compatibility</a>.</li> <li>• The camera may take up to 1 minute to power up after being connected to the NVR. Wait two minutes before following the steps below.</li> <li>• Ensure the camera is connected to your NVR or to your local network.</li> <li>• If you are not using PoE, you must connect the camera to a 12V DC power adapter (not included).</li> <li>• If the camera is connected to the LAN, you must search your network for cameras using the NVR. See the NVR's instruction manual.</li> <li>• Ensure your NVR is properly connected to a TV/monitor.</li> <li>• There may be an issue with your extension cable run. Connect the camera to the NVR using a different Ethernet cable.</li> </ul>
Picture is too bright	<ul style="list-style-type: none"> <li>• Ensure your camera isn't pointed directly at a source of light (e.g., sun or spot light).</li> <li>• Slide the sunshade forward to block excess light.</li> <li>• Move your camera to a different location.</li> <li>• Check the brightness and contrast settings on the NVR.</li> </ul>
Picture is too dark	<ul style="list-style-type: none"> <li>• If using during the day, the camera may not be getting enough light. Slide the sunshade backwards to let in more light.</li> <li>• Check the brightness and contrast settings on the NVR.</li> </ul>
Night vision is not working	<ul style="list-style-type: none"> <li>• The night vision activates when light levels drop. The area may have too much light.</li> </ul>
Picture is not clear	<ul style="list-style-type: none"> <li>• Check the camera lens for dirt, dust, spiderwebs. Clean the lens with a soft, clean cloth.</li> <li>• Make sure that the cable run is within the limitations specified in the section 'Cable Extension Options'.</li> <li>• Remove the vinyl film from the camera lens when your installation is complete.</li> </ul>
Bright spot in video when viewing camera at night	<ul style="list-style-type: none"> <li>• Night vision reflects when pointing a camera through a window. Move the camera to a different location.</li> </ul>
Picture is in color in dark conditions	<ul style="list-style-type: none"> <li>• This camera comes with an image sensor that is extra sensitive to light, meaning that the camera stays in color mode at low-light conditions. For instructions on how to make your camera switch to night mode, visit <a href="http://lorex.com">lorex.com</a>, and search for "How do I make my camera switch to night mode?".</li> </ul>